

VEGAS 9



Narzędzia potrzebne do montażu



UWAGA !!!

MONTOWANIE USZKODZONYCH
ELEMENTÓW POWODUJE UTRATĘ
GWARANCJI

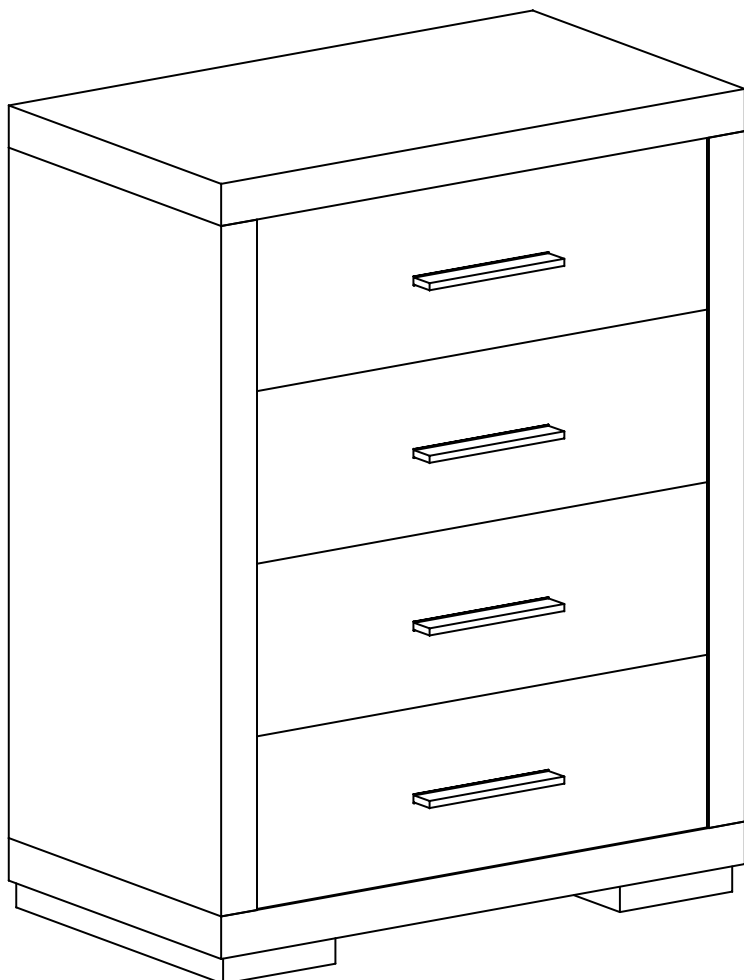

Nr	D[mm]	S[mm]	G[mm]	Ilość
1	703	407	48	1
2	703	407	48	1
3	783	405	48	1
4	783	405	48	1
5	690	834	2,5	1
6	597	190	16	4
7	350	165	16	4
8	544	165	16	4
9	350	165	16	4
10	575	690	2,5	4

W przypadku reklamacji proszę podać numer pakowacza znajdujący się na kartonie.

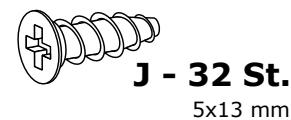
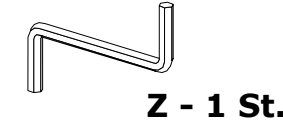
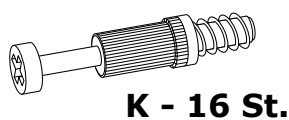
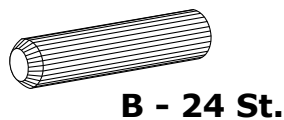
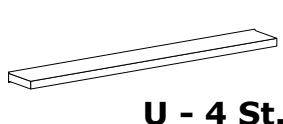
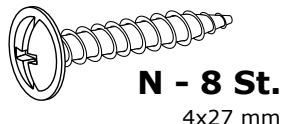
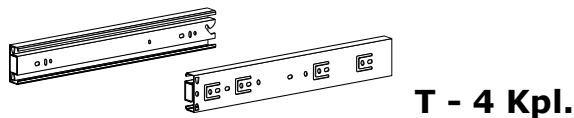
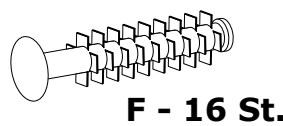
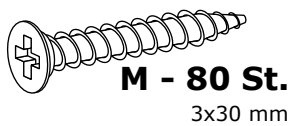
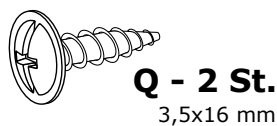
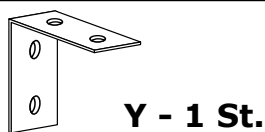
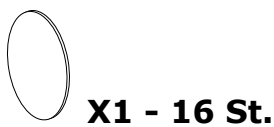
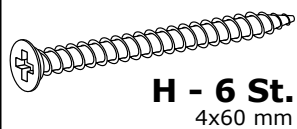

I

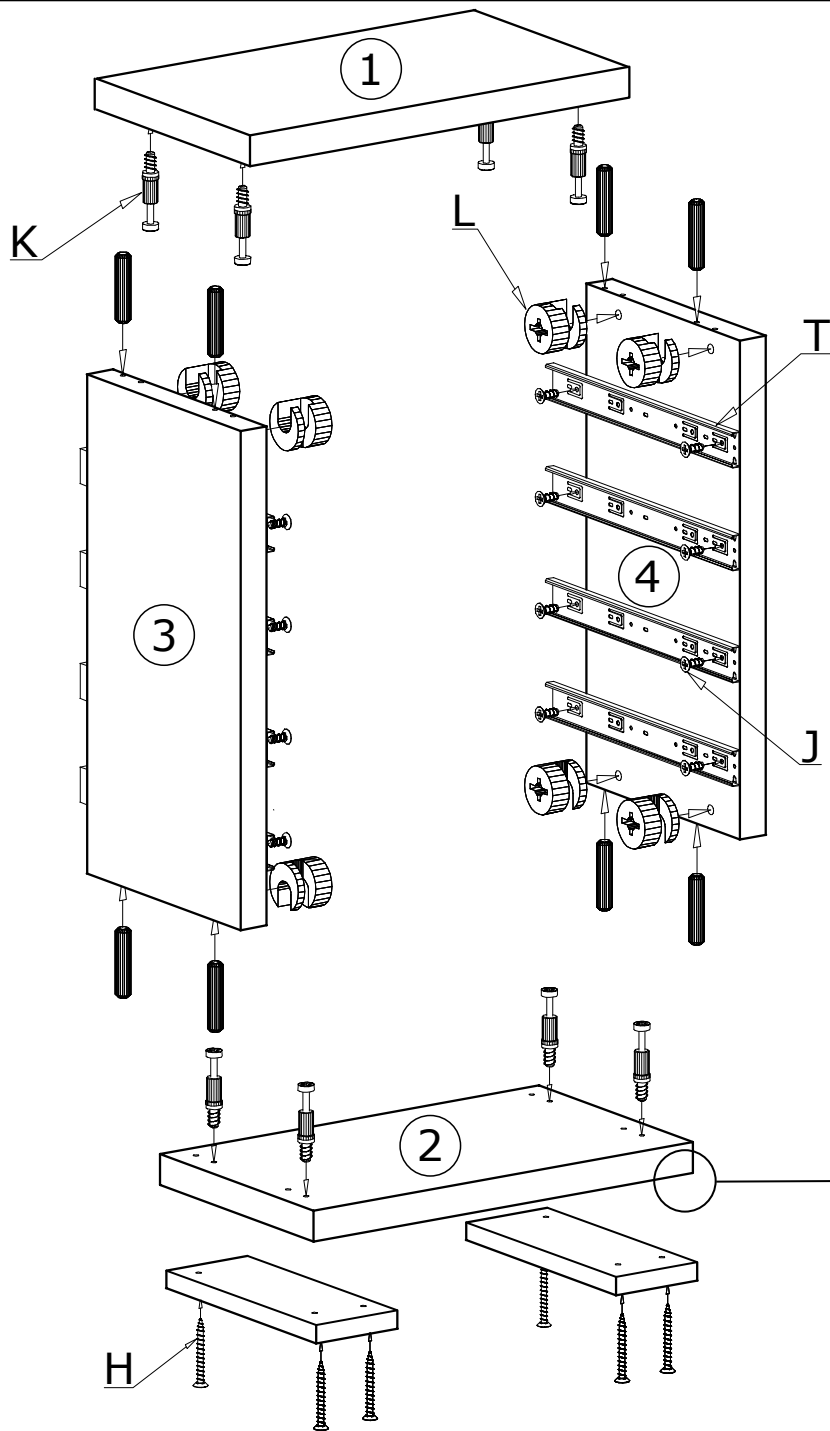

II

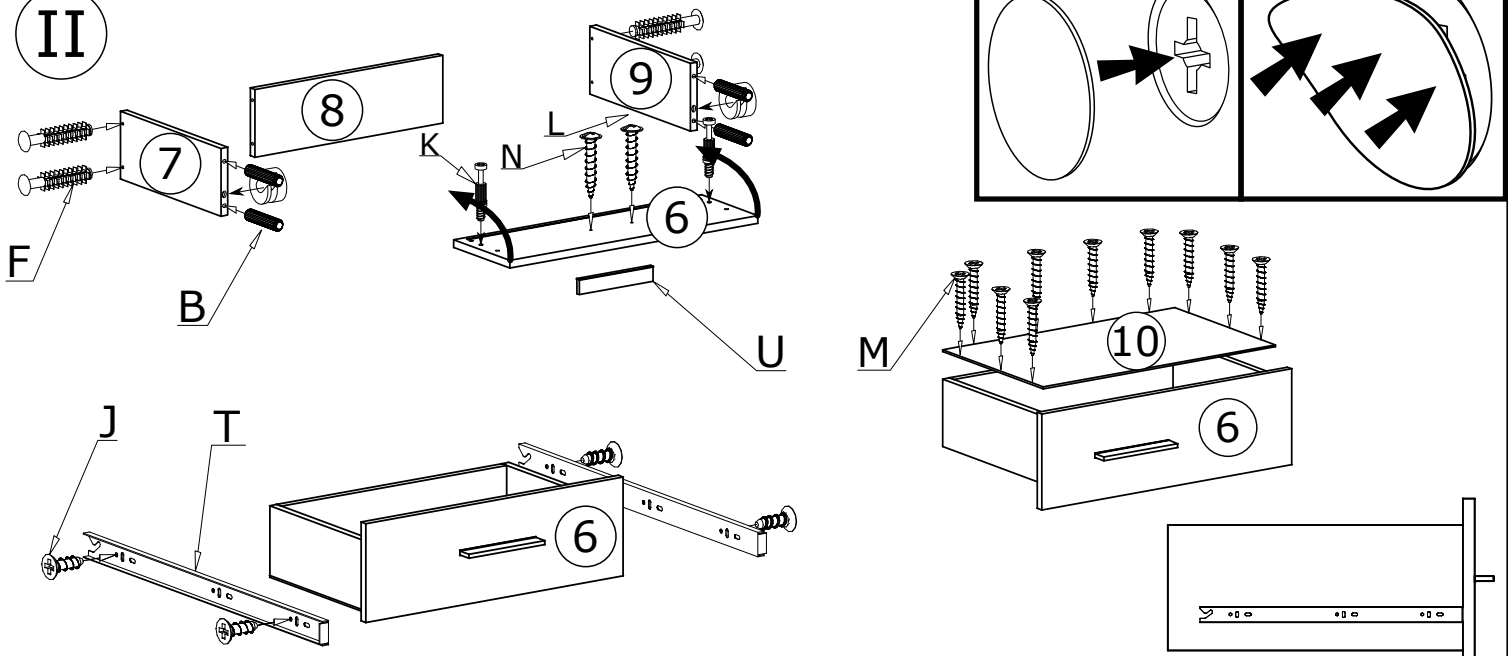

III

40X 

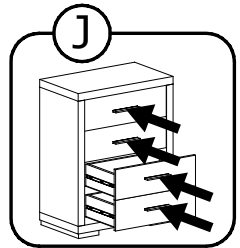
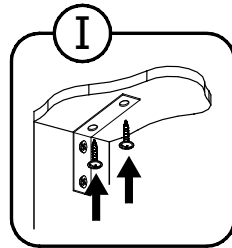
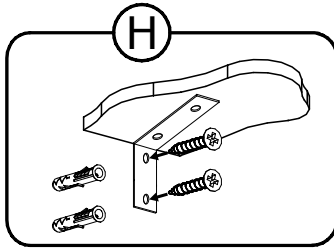
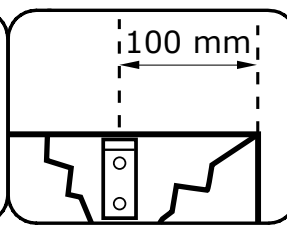
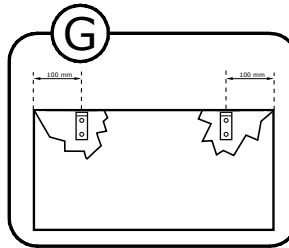
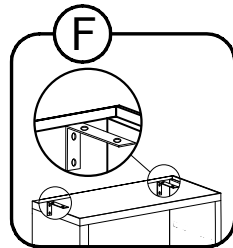
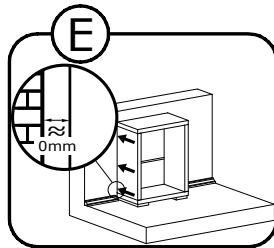
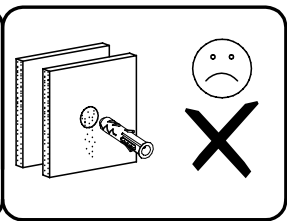
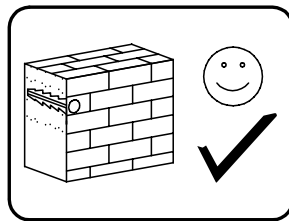
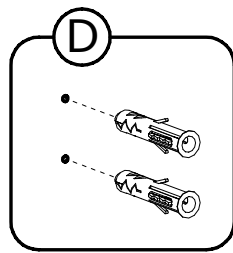
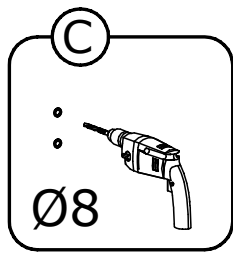
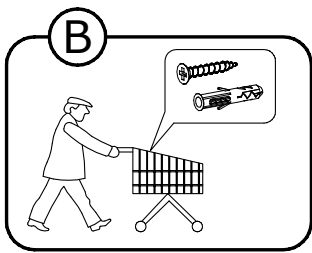
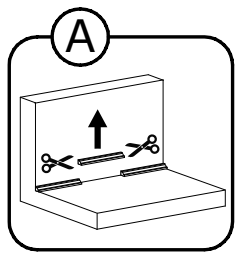
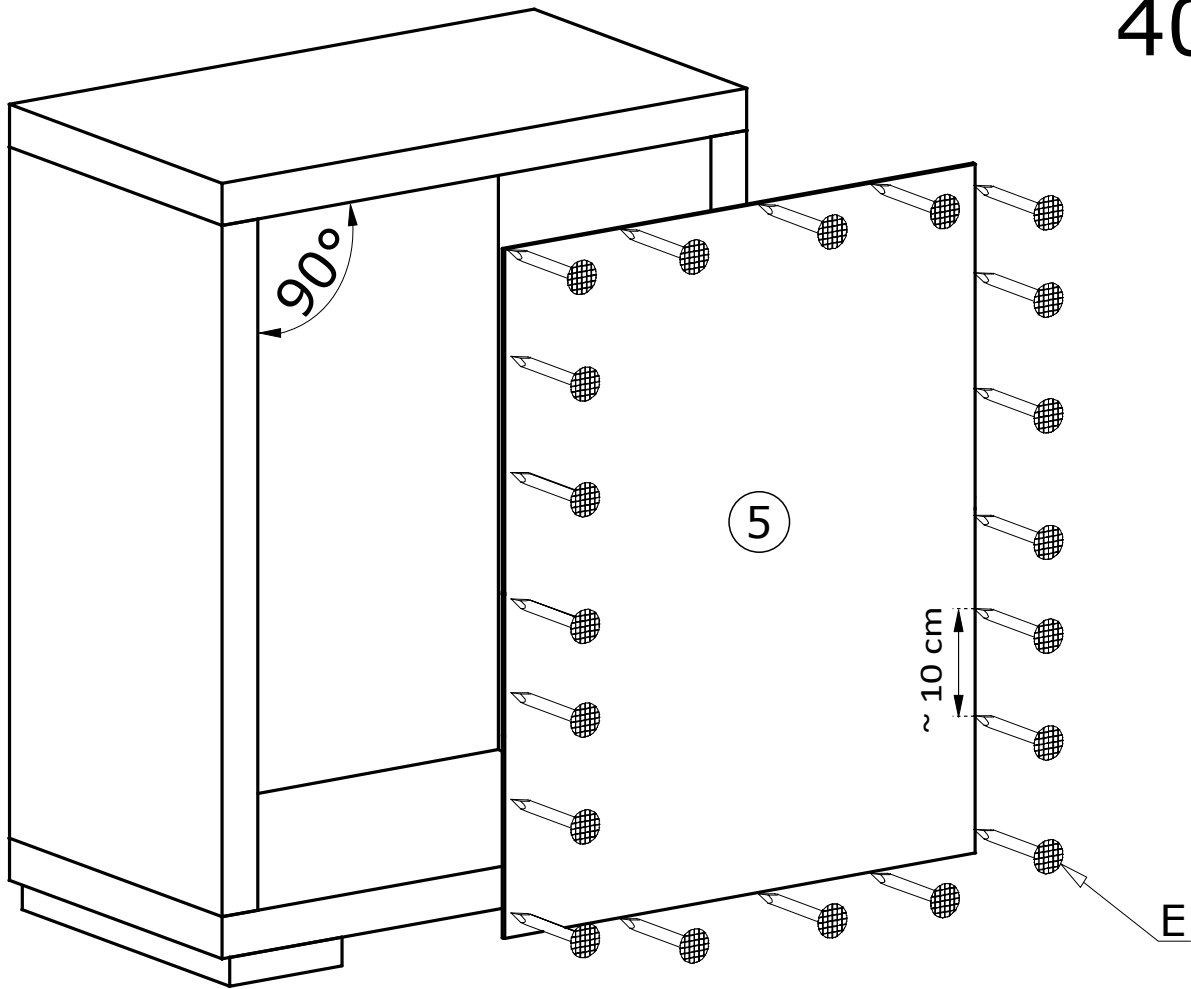

IV

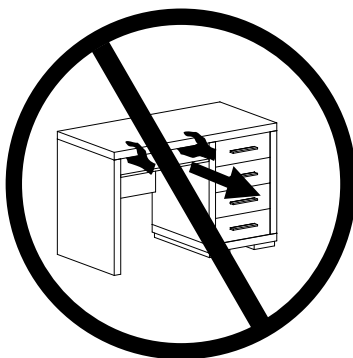
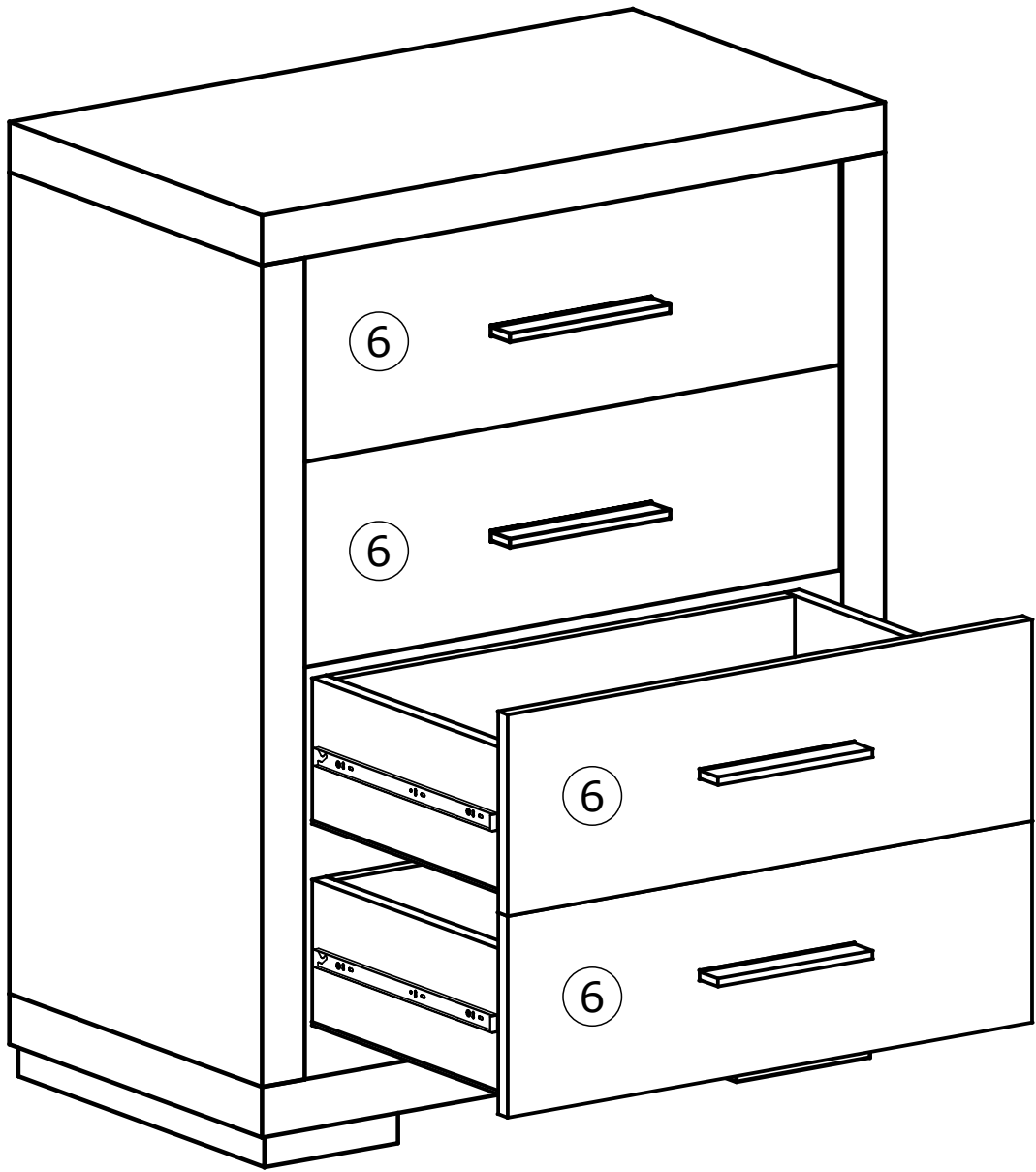

MONTAŻ/DEMONTAŻ PROWADNIC

1



2



3

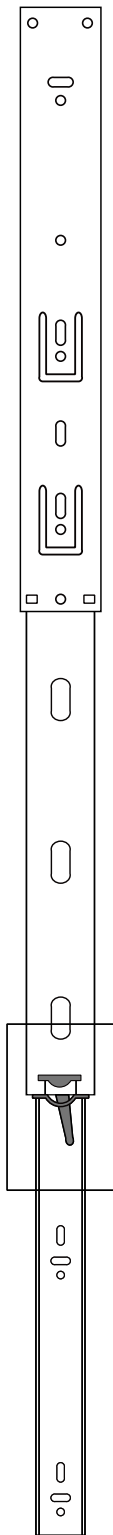

4

